

digital

AUTOMATIC MAGNETIC TAPE CONTROL TYPE

00

57A

PROGRAMMED DATA PROCESSOR - 4

The Automatic Magnetic Tape Control Type 57A, operating through Interface Logic, such as the 520, 521, or 522, transfers information between Programmed Data Processor-4 and up to eight tape transports. Data transmission format is compatible with IBM high and low densities (800-556 and 200 characters per inch, respectively) in either BCD or binary parity modes. Transports can be Digital's Type 50 or Type 570, or IBM Types 729 II, IV, V, VI, or (with certain restrictions) the 7330. The transports are capable of operating at the following densities: 200 cpi only, Type 50; 200 and 556 cpi only, Type 570 or IBM Types 729 II, IV, and 7330; all three densities, IBM Types 729 V and VI.

The following functions are controlled by various combinations of iot (in-out transfer) commands:

- Write
- Write End of File
- Write Blank Tape
- Read
- Read Compare
- Space Forward
- Space Backward
- Rewind
- Rewind/Unload
- Gather Write
- Scatter Read
- Write Continuous
- Read Continuous
- Read Compare/Read
- Read/Read Compare

Tape transport motion is governed by one of two control modes: Normal, in which tape motion starts upon command and stops automatically at the end of the record; and Continuous, in which tape motion starts on command and continues until stopped by the program when synchronizing flags or status conditions appear.

All commands are transmitted via the PDP-4 accumulator. The current address (CA) and word count

(WC) registers are located in the Type 57A. They are loaded from the PDP accumulator and modified by the control during transfers. All data transfers are executed through the PDP Data Interrupt. The Program Interrupt mode allows the computer to continue computation without having to wait for tape flags. The programmer enables the desired interruptions.

Tape functions may be monitored by the program either during or at the end of an operation. They may be altered during an operation to a limited degree. Several types of possible error conditions are sensed for throughout an operation and may be interrogated at any time.

In normal operation six iot commands initiate reading or writing of one record. When the word count exceeds the number stored in the WC the transport is stopped and the control is free for another command. In continuous operation, any number of records is written or read without the need for further transport commands except stop.

Words can be transferred to or from consecutive memory locations (block transfer), written from non-consecutive memory locations (gather write), or read to non-consecutive memory locations (scatter read). In writing or reading, the 18-bit binary word is divided into three characters from left to right; that is, bits 0-5 contain the first character, bits 6-11 the second, and bits 12-17 the third.

Two crystal clocks are used to generate one of three character writing rates, depending on the density (200, 556, 800) specified by the programmer.

The Type 57A Control consists of 75 System Modules in a standard DEC cabinet along with the Interface equipment. The Control is pluggable to the PDP-4 and wired to the Interface. The Type 520 and 521 Interfaces are pluggable, through a 50-pin connector and cable, to the Type 50 and Type 570 Transports, respectively. The 522 Interface is pluggable through the standard IBM plug to either the 729 or 7330 transports.

FUNCTIONS

The functions of the Type 57A Control are controlled by combinations of the following iot instructions:

- mscr — 707001 — Skip if the tape control ready (TCR) level is 1. A 1 is added to the Program Counter if the tape control is free to accept a command. The TCR flag is connected to the Program Interrupt.
- mcd — 707042 — Disable the TCR flag from the Program Interrupt and clear command register. Clear word count overflow (WCO) flag. Clear end of record (EOR) flag.
- mts — 707006 — Disable the TCR flag from the Program Interrupt, turn off the WCO flag and EOR flag, and select the unit, the mode of parity, and the density from the AC. The AC bit assignments are as follows:

AC bit 7 (521 & 522 Interfaces only)

- 0 = high sense level
- 1 = low sense level

AC bit 8

- 0 = 200 or 556 density
- 1 = 800 or 556 density

AC bit 14

- 0 = 200 density
- 1 = 556 density

		AC bit 8	
		0	1
AC bit	0	200	800
14	1	556	556

AC bit 13:

- 0 = even parity, (BCD)
- 1 = odd parity (binary)

AC bits 15-17:

These three bits select one of eight tape units, addresses 0-7.

- msur — 707101 — Skip if the tape transport is ready (TTR). The selected tape unit is checked, using this command, and must be free before the following mtc command is given.
- mtc — 707106 — Place AC bits 9-12 in the tape control command register and start tape motion. Bit 12 selects Normal motion if 0 and

Continuous motion if 1. AC bits 9-11 are decoded as follows:

- 0 — no operation
- 1 — rewind
- 2 — write
- 3 — write end of file (EOF)
- 4 — read compare
- 5 — read
- 6 — space forward
- 7 — space backward

- mnc — 707152 — Terminate the continuous mode. (The AC is cleared.)
- mswf — 707201 — Skip if the WCO flag is a 1. The flag is connected to the Program Interrupt.
- mdwf — 707202 — Disable WCO flag.
- mcwf — 707222 — Clear WCO flag.
- mewf — 707242 — Enable WCO flag.
- miwf — 707262 — Initialize WCO flag.
- mrc — 707244 — Switch mode from read compare to read
- mrd — 707204 — Switch mode from read to read compare
- msef — 707301 — Skip if the EOR flag is a 1. This flag is connected to the Program Interrupt.
- mdef — 707302 — Disable ERF.
- mcef — 707322 — Clear ERF.
- meef — 707242 — Enable ERF.
- mief — 707362 — Initialize ERF, clear and enable.
- mtrs — 707314 — Read tape status bits into the AC. The bit assignments are:
 - 0 — data request late
 - 1 — tape parity error
 - 2 — read compare error
 - 3 — end of file flag set
 - 4 — write lock ring out
 - 5 — tape at load point
 - 6 — tape at end point
 - 7 — tape near end point (520), last operation write (521 and 522)
 - 8 — tape near load point (520), B control using transport (521 with multiplex transport), write echo ok (522)
 - 9 — transport rewinding
 - 10 — tape miss character
- mcc — 707401 — Clear CA and WC
- mca — 707405 — Transfer AC bits 5-17 to CA and clear CA and WC.
- mwc — 707402 — Transfer AC bits 5-17 to WC.
- mrca — 707414 — Transfer CA bits 5-17 to AC bits 5-17.

AUTOMATIC SAFEGUARDS

END POINT — If the end point is reached during reading or writing, the control ignores the end point and finishes the operation (ample tape is allowed). Beyond the end point, tape commands specifying forward direction are illegal and the tape will not respond to such commands. If the end point is passed during spacing, the transport is shut down regardless of word count.

LOAD POINT — If the load point is reached during back spacing, the transport is stopped regardless of word count. At load point, a space back command is legal, and the tape may be unloaded. When the write command is given at load point, tape is erased 3 inches beyond load point before writing the first record. After giving a read command at load point, the read logic is disabled until the load point marker is past the read head before the read logic is turned on.

WRITE LOCK RING — Without the write lock ring in the tape reel, writing is illegal and the transport will not respond to a write command.

FORMAT CONTROL — If the PDP-4 halt command is given during Normal reading or read-comparing, the tape proceeds to the end of record and the control shuts down the transport. If a halt is given in Continuous reading or read-comparing, the transport will proceed to end of tape and shut down. If a halt command is given in Normal spacing, the transport will proceed to EOR and shut down. If halt is given during Continuous spacing, the transport will proceed until WC overflows or until it sees a file marker, load point, or end point, then shut down.

If halt is given during writing in the Normal mode, the last word to be transferred is written, the rest of the record is written as zeros, and the transport is shut down. If halt is given during writing in the Continuous mode, the record is completed, then zeros are written to the end of the tape. If a WC overflow occurs during a Normal read or read compare, the transport proceeds to EOR before shutting down.

Sample Basic Program

All operations begin with the program events shown in the following Basic Program Flow Chart and Sample Basic Program Sequence. When the main program branches to this sequence (having received, for example, a high priority data request from the tape control) the control and transport are interrogated for availability (mscr, msur) and if ready are instructed to carry out the specified task (mts, mtc). If the task is one of the eight listed in the instruction list under mtc, the mscr instruction completes the

program sequence. If not, the program branches at α to one of the routines (write, read, etc.) shown on the pages following the basic program, returning afterwards to β in the basic program.

The basic sequence for Normal and Continuous operation is shown below. Exact timing depends upon the Interface Logic (Type 520, 521, 522) used and is given in the manuals supplied with this equipment.

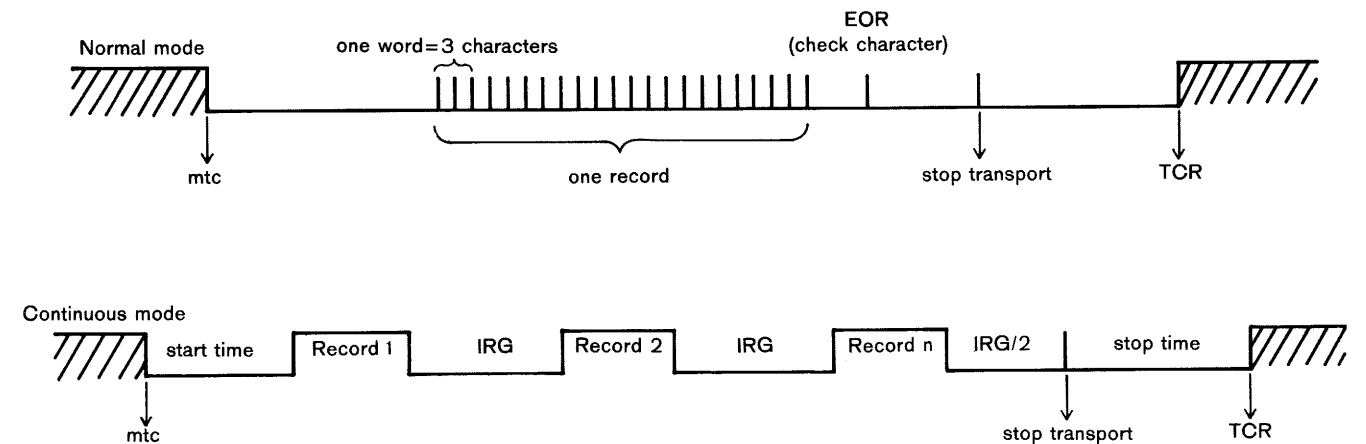

BASIC PROGRAM FLOW CHART

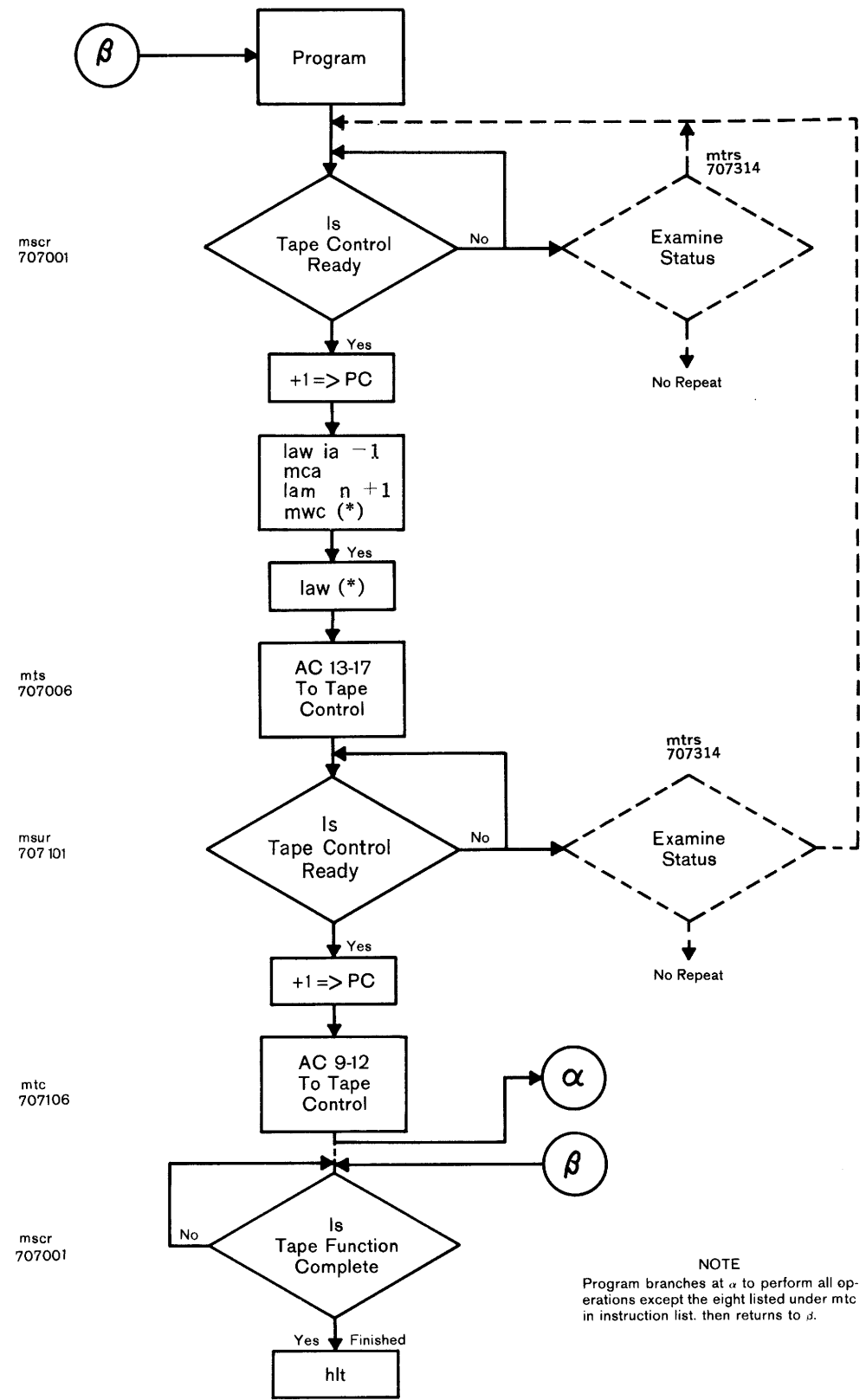

NOTE
Program branches at α to perform all operations except the eight listed under mtc in instruction list, then returns to α.

SAMPLE BASIC PROGRAM SEQUENCE

- begin, mscr /skip if tape control free
- jmp. - 1 /tape control not free, jump /back to mscr instruction
- law ia - 1 /load AC with initial address /minus one
- mca /transfer AC to CA
- lam - n + 1 /load AC with complement of /number of words to be trans- /ferred plus one
- mwc /transfer AC to WC
- law (*) /load AC 9-17 with select in- /formation*
- mts /transfer AC to control with /parity density and unit number
- msur /skip if tape transport ready
- jmp. - 1 /transport not ready, jump /back to msur instruction
- mtc /transfer AC to control with /command and tape motion /mode
- wait, mscr /wait for tape function to com- /plete
- jmp. - 1 /tape function not complete, /jump back to mscr
- hlt /operation completion

*A set of mnemonics that specifies all tape operations is furnished with the Type 57A.

PROGRAMMING IN THE INTERRUPT MODE —
When the TCR flag causes an interrupt in the operating program, the flag may be tested by using the mscr instruction. The TCR flag must be cleared with the mcd command before dismissing the interrupt. WCO and ERF flags must be disabled before dismissing the interrupt, with the option of clearing or not clearing the flags.

WRITE NORMAL

One or two characters, n words and one or two characters, or n words can be written in BCD mode. When writing BCD, convert all characters (00_8) to (12_8). The WCO flag is set during the writing of the next to last word in a record. In a one-word transfer only, the WCO flag is set before the data transfer begins. The ERF flag is set when the EOR (check character) is written. Parity is read and compared while writing.

The data request late bit will be set if the PDP-4 does not transfer a new word to or from the control before another data request is given. When a 522 Interface is being used, a write echo status appears if the character zero (00_8) is written BCD.

WRITE END OF FILE (EOF)

The end-of-file marker is written 17_8 BCD. It is automatically detected during reading or spacing. One instruction, mtc, initiates this operation, carries it out, and stops the transport. WCO does not occur. The ERF flag is set when the EOR (check character) is detected. CA and WC are not modified.

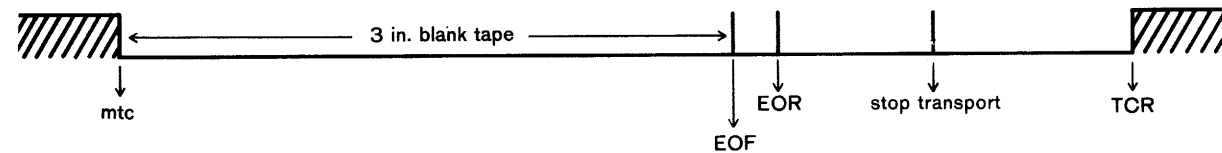

WRITE BLANK TAPE

To write three inches of blank tape, the programmer gives a write EOF command and then a space backward command. In either case CA and WC are not modified.

READ NORMAL

One or two characters, n words and one or two characters, or n words can be read in either parity mode. The WCO flag is set during the record when the specified word count is exceeded. The ERF flag is set when the EOR (check character) is detected. Parity errors may be read by examining the appropriate tape status bit.

When reading in BCD mode, convert all (12_8) to (00_8). When reading in binary mode, and an EOF is detected, the parity error status bit will be set. If, while reading, a character does not appear within the allotted time, the miss character status bit will be set.

READ COMPARE

Words from tape may be compared against consecutive or non-consecutive locations in core memory for equality. An inequality sets the read compare error flag and the CA holds the location of the inequality. Read compare is like read, except that WCO occurs before the last word is compared. The ERF is always set at EOR. Should WCO occur before EOR, the ERF will be set upon comparison of the last word and at EOR.

SPACE

Spacing forward or backward one record is automatic and does not modify the CA or WC. Spacing n records either direction can be done in the Continuous mode, and continues until a WCO occurs or EFF is encountered, whichever comes first. If CA is cleared initially, it will contain the record count and may be examined by the program. The programmer may command stop prematurely with mnc, after which the tape stops as soon as EOR is seen. The parity error flag will be set if a parity error is detected.

REWIND. REWIND/UNLOAD

Rewind and Rewind/Unload do not require the use of CA, WC, Data Interrupt mode, or Program Interrupt mode. Rewind/Unload is selected by specifying Rewind and Continuous mode. The transport will not respond to a forward command for 12 milliseconds after the tape has been rewound and stopped at Load Point.

GATHER WRITE OR SCATTER READ

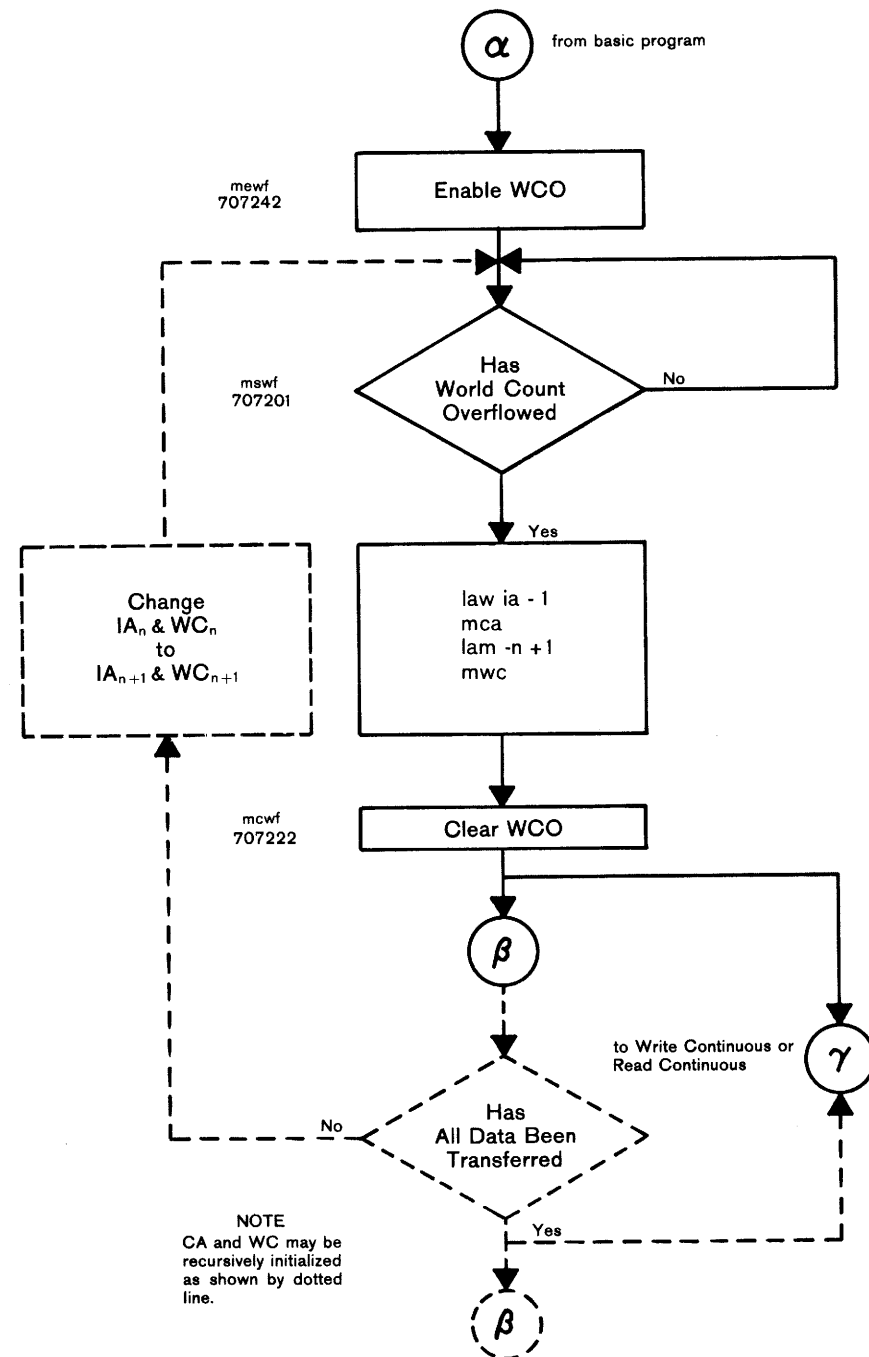

GATHER WRITE OR SCATTER READ

/branches from basic program

gather, mewf	/enable WCO flag
mswf	/skip if WCO flag is a 1
jmp. - 1	/WCO flag not set, jmp back /to mswf instruction
newia, law ian	/load AC with new initial /address
mca	/transfer AC to CA
lam wcn	/load AC with new word count
mwc	/transfer AC to WC
mcwf	/clear WCO flag
jmp wait	/return to "wait" in basic /program

In gather writing, data in non-consecutive groups of memory locations may be written in continuous records. In scatter reading, groups of words in a continuous record may be transferred to non-consecutive groups of memory locations.

Timing restrictions are given in the Interface equipment descriptions.

WRITE CONTINUOUS

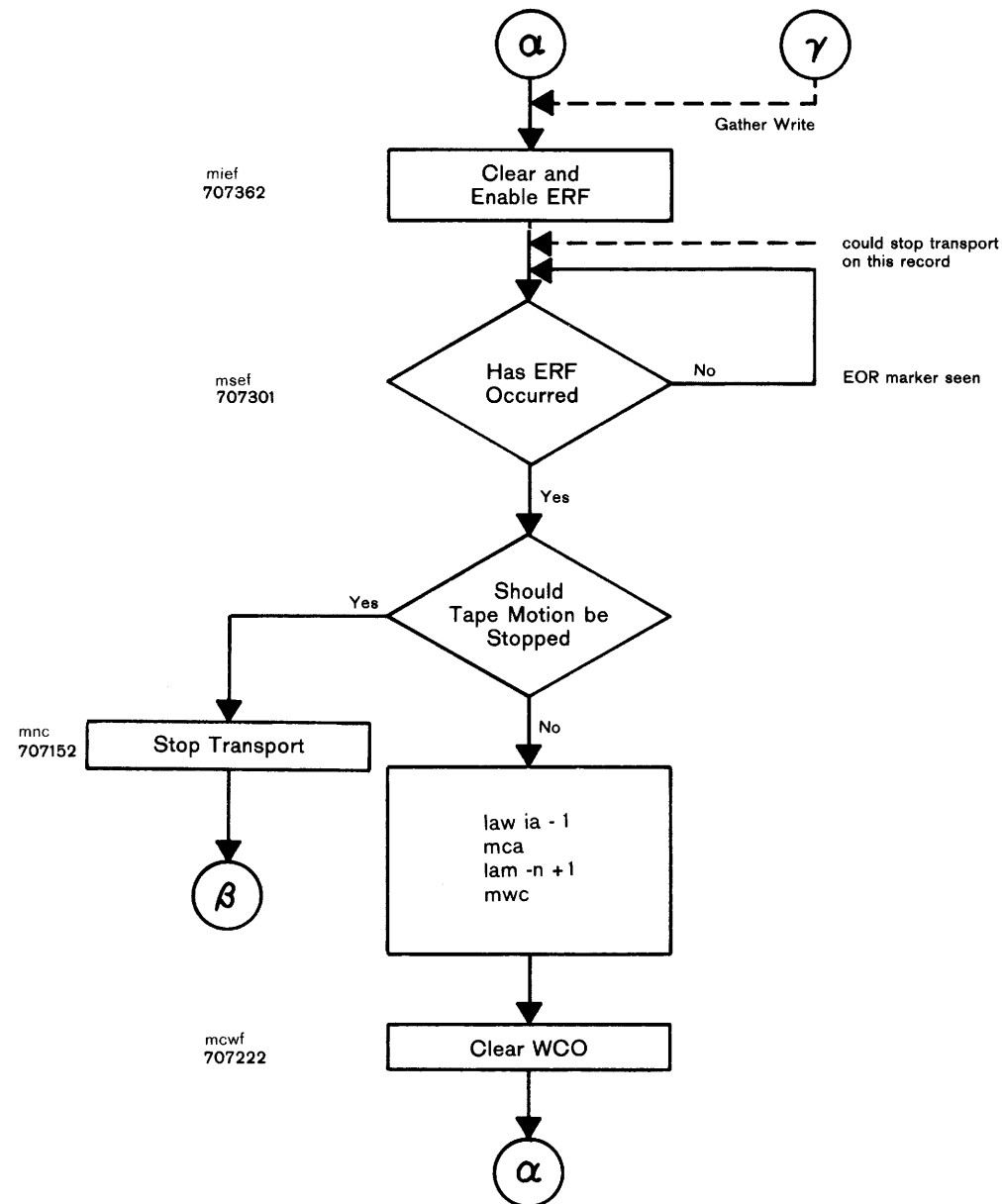

WRITE CONTINUOUS

/branches from basic program

conwrt, mief	/iot 707362 clear and enable /EOR flag
msef	/skip if EOR flag is a 1
jmp. - 1	/ERF not set, return to msef /instruction
lac flag	/flag is a register that contains ones if the transport /is to be stopped
sza	/test flag
jmp stop	/flag is set, jump to stop /routine
law ia - 1	/get new initial address for /next record
mca	/transfer AC to CA
lam - n + 1	/load AC with complement of /new word count plus 1
mwc	/transfer AC to WC
mcwf	/clear and disable WCO
jmp conwrt	/go back to conwrt
stop, mnc	/terminate continuous mode
jmp wait	/go back to basic program

The ERF flag is set after EOR is written. It may be cleared or disabled at any time.

WCO flag is set before the last character of a record is written and may be cleared after the EOR (check character) occurs but must be cleared before the next record is written.

To stop the transport after a given record, the mnc command must be given before, or within 0.5 millisecond after, the EOR following that record.

READ CONTINUOUS

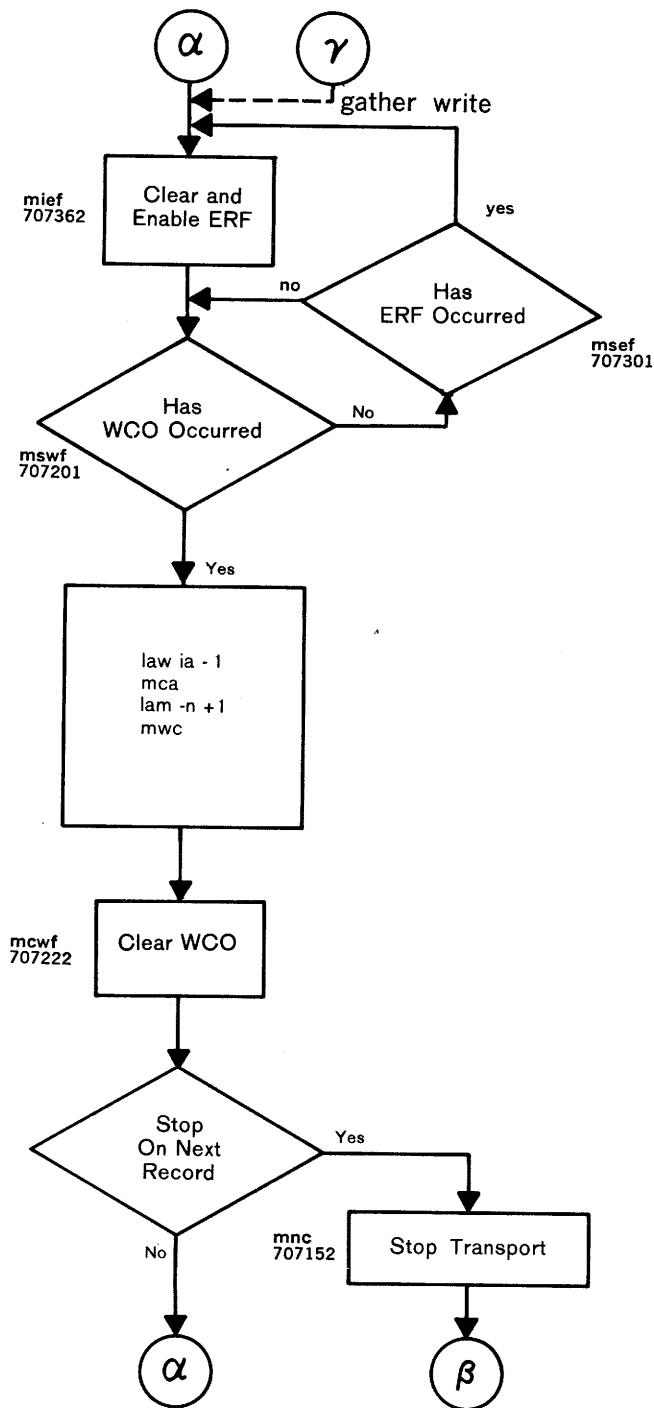

READ CONTINUOUS

/branches from basic program

conrd, mief	/clear and enable ERF
mswf	/skip if WCO set
jmp. + 2	/test ERF
jmp conia	/reinitialize control
msef	/skip if ERF is set
jmp. - 4	/ERF not set, jump to mswf /instruction
jmp conrd	/ERF but no WCO
conia, law ia - 1	/load AC with initial address /minus 1
mca	/transfer CA to AC
lam -n + 1	/load AC with complement /of word count plus 1
mwc	/transfer AC to WC
mcwf	/clear WCO flag
lac flag	/flag determines whether /stop transport on /next record or continue /reading
sza	/test flag
jmp stop	/flag is set
jmp conrd	/return to conrd and wait /for next ERF
stop, mnc	/stop transport
jmp wait	/go back to basic program

The WCO flag is set whenever word count is exceeded, stopping data transfer. To stop the transport after a WCO flag, the mnc command must be given before the EOR following the record in which the flag was set, or within 0.5 millisecond afterwards. ERF is set once per record at the EOR marker. The programmer may combine records, gather read, into consecutive locations of core by synchronizing with WCO; that is, n records are read before a word count overflow is encountered.

READ COMPARE/READ

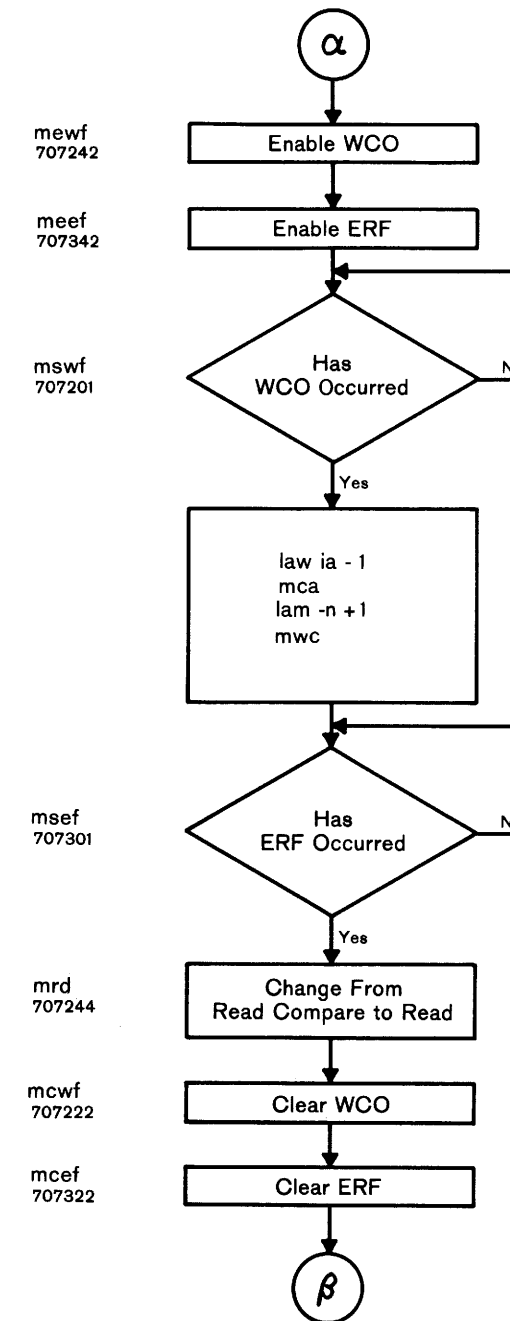

READ COMPARE READ

/branches from basic program

rdcmrd, mewf	/enable WCO
meef	/enable ERF
mswf	/skip if WCO flag is set
jmp. - 1	/return to mswf instruction
law ia - 1	/load AC with new initial /address for reading
mca	/transfer AC to CA
lam -n + 1	/load AC with new word /count for reading
mwc	/transfer AC to WC
msef	/skip when last word com- /pared (ERF)
jmp. - 1	/go back to msef instruction
mrc	/change control command /from read compare to read
mcwf	/clear WCO
mcef	/clear ERF
jmp wait	/go back to basic program

The programmer may change from read compare to read in the middle of a record by synchronizing with WCO and ERF and commanding mrc. In the continuous mode the switch may take place over the inter-record gap. Switching on consecutive words is illegal. If read compare errors are ignored, read compare/read provides a convenient method of spacing over words to read sections of records.

READ/READ COMPARE

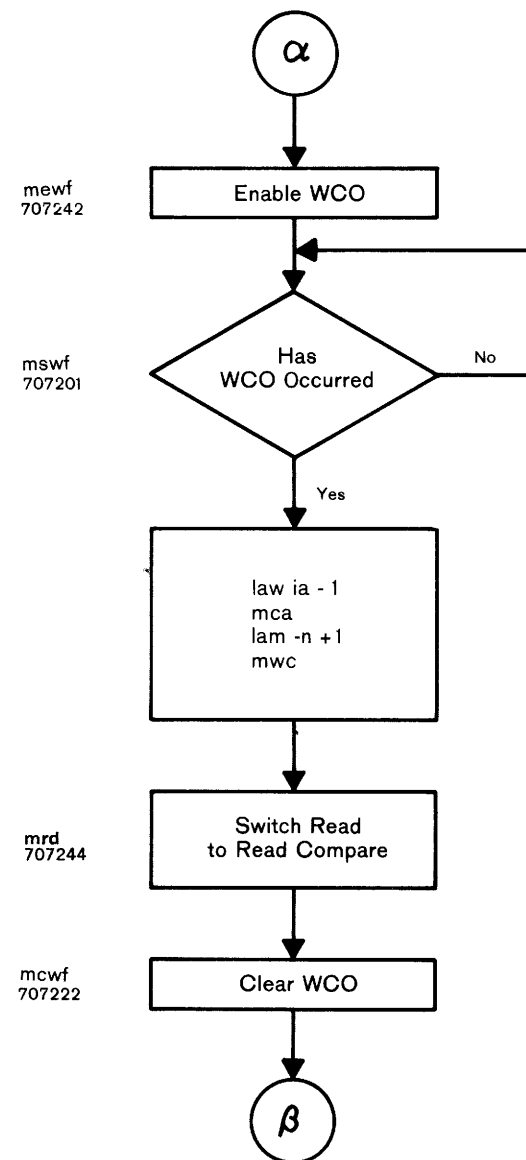

READ/READ COMPARE

/branches from basic program

rdrdcm, mewf	/enable WCO
mswf	/skip if WCO is set
jmp.-1	/WCO not set, jump back to /mswf instruction
law ia - 1	/load AC with initial address /for read compare
mca	/transfer AC to CA
lam -wc + 1	/load AC with complement of /n words for read compare
mwc	/transfer AC to WC
mrd	/switch control command /from read to read compare
mcwf	/clear WCO flag
jmp wait	/return to basic program

Read/Read Compare can be done only in low density format, otherwise the comments under Read Compare/Read apply.

CONTROL LOGIC

The Type 57A Control logic and its interface connections with the PDP-4 are shown in the accompanying block diagram. A detailed list of logical elements is given below. It includes two data registers, a Current

Address register, a Command register, and the control logic itself, consisting of counters, flip-flop registers, delays, and pulse generators.

REGISTERS

Data Buffer	An 18-bit register that communicates between the PDP-4 memory buffer and the data accumulator	Word Count Register	A 13-bit register that contains the number of words to be transferred
Data Accumulator	An 18-bit register that assembles a word from characters presented by the read buffer, or transfers words one character at a time to the write buffer	Command Register	A 3-bit register that transfers AC bits 9, 10, and 11 to a decoder where one of eight commands is decoded
Current Address Register	A 13-bit register that controls the memory address register and may be examined by the program	Unit Register	A 3-bit register that transfers AC bits 15, 16, and 17 to a decoder where selection of tape unit, density, parity, and tape motion are decoded

CONTROL LOGIC

Clock Counter	A 2-bit counter that generates 200 density timing	End of File	A level generated when end of file (17 ₈) is encountered
Character Counter	A 2-bit counter that controls which character of a word is being operated on	Motion Delay	A level that indicates one of the tape motion delays has been initiated; also used to disable the clock
Continue	A flip-flop that stores AC bit 12, used to select either the continuous or normal mode	ERF Enable	A logical gate that disables or enables the ERF flag depending on the program
Job Done	A flip-flop set after the stop command is given, indicating transport is stopped and tape control is ready	Word Count Overflow Enable	A logical gate that disables or enables the WCO flag, depending on the program
Parity	A flip-flop that stores AC bit 13 for selecting odd or even parity	Write Pulse	A pulse amplifier that gates the write buffer in the Interface
Read Compare Error	A single flip-flop set inclusively when an error occurs in the read compare mode	Character Pulses	Three pulse amplifiers that generate three closely spaced pulses at the end of each word
Density	Two flip-flops that store AC bits 8 and 14 for selecting character density	Read Pulses	Three pulse amplifiers used to gate pulses from the read buffers to the data accumulator
Parity Error	A flip-flop set when a parity error occurs; may be examined by the program	High-Low	A single flip-flop that stores AC bit 7 for selecting one of two thresholds above which read signals are sensed
End of File Flag	A flip-flop set by the end of file mark on which the programmer may synchronize	Data Request Late	A single flip-flop set when a second data request is made of the PDP-4 following an unanswered data request. The flag may be examined
Word Count Overflow	A flip-flop set when the specified number of words has been transferred; the programmer may synchronize on WCO	Missed Character	A single flip-flop set during tape to control transfers when a character is missed. The flip-flop is read after the tape function is completed
Tape Control Ready	A level set when the control is ready for operation	Write Echo	A flip-flop set when no write echo is received after writing a character
Data Request	A level that interrupts the computer with a highest priority request		

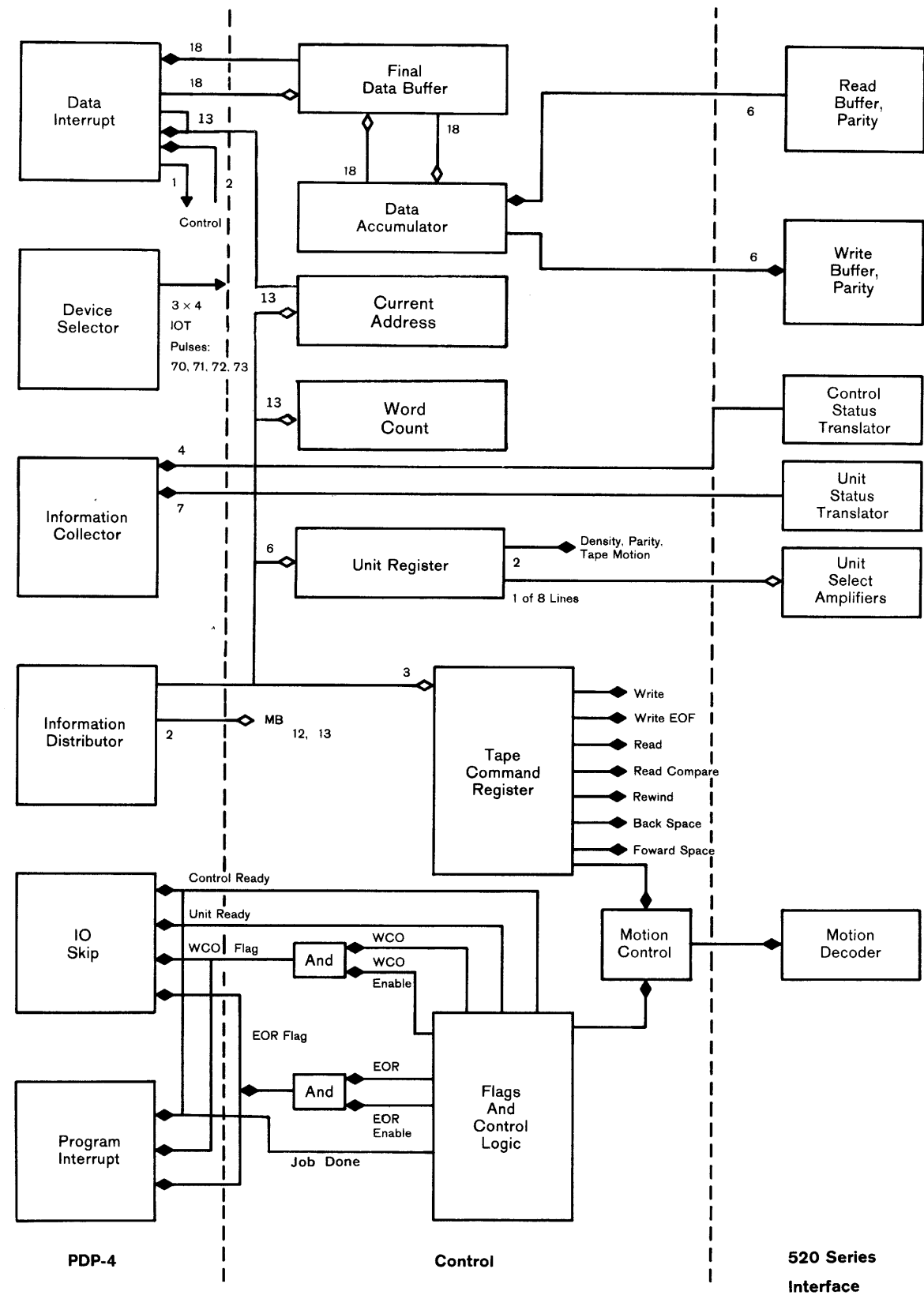

TYPE 57A CONTROL